



STEEL SLIDING DOORS

STANDARD | LUX | MAGNETYT

Closets
Wall Units



STANDARD

system



Standard - a narrow and slender profile, with a groove, forming a delicate door frame. Doors made with the use of this profile are light and slender, which gives sublime character to the construction. Thanks to its delicate line, the Standard profile emphasizes the material that is inserted in the front. Wardrobes designed using this profile are perfect for narrow hallways, in the attic and in children's rooms in both classic and contemporary styles.

The Standard system enables the production of sliding and hinged doors, as well as the use of decorative strips to match the colour of the system.

PARAMETERS

- max door height: 2.75 m
- max door width: 1.25 m

PROPERTIES

- anti-jumping function protects the door against falling out of the bottom track
- buffer strips with short and long hair reduce vibrations when closing the door and protect the interior against dust
- rollers equipped with bearings ensure light door sliding with ease
- quiet work of the running gear
- possibility of using the door closers ensuring soft closing of the door



PROFILE COLORS

white



black



mat silver



mat gold





Standard



LUX system



Lux - a system with wide edges and a regular, classic shape. The smooth surface and a light indent in the central part of the profile make it extremely comfortable to use, serves as a handle. The regular shape of the frame gives a gentleness to the wardrobe and thus the whole interior. Due to its appearance, Lux is widely used in interiors of various styles, from classic through retro, vintage, eclectic to rustic.

The Lux system enables the production of sliding, pivoting and slant doors and the combination of various insert materials within one door. It is also possible to use decorative strips in the colour of the system.

PARAMETERS

- max door height: 2.75 m
- max door width: 1.25 m

PROPERTIES

- anti-jumping function protects the door against falling out of the bottom track
- buffer strips with short and long hair reduce vibrations when closing the door and protect the interior against dust
- rollers equipped with bearings ensure light door sliding with ease
- quiet work of the running gear
- possibility of using the door closers ensuring soft closing of the door

6



PROFILE COLORS

white



black



silver



mat gold



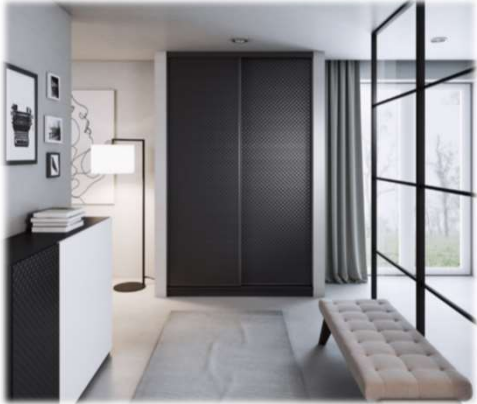

Lux

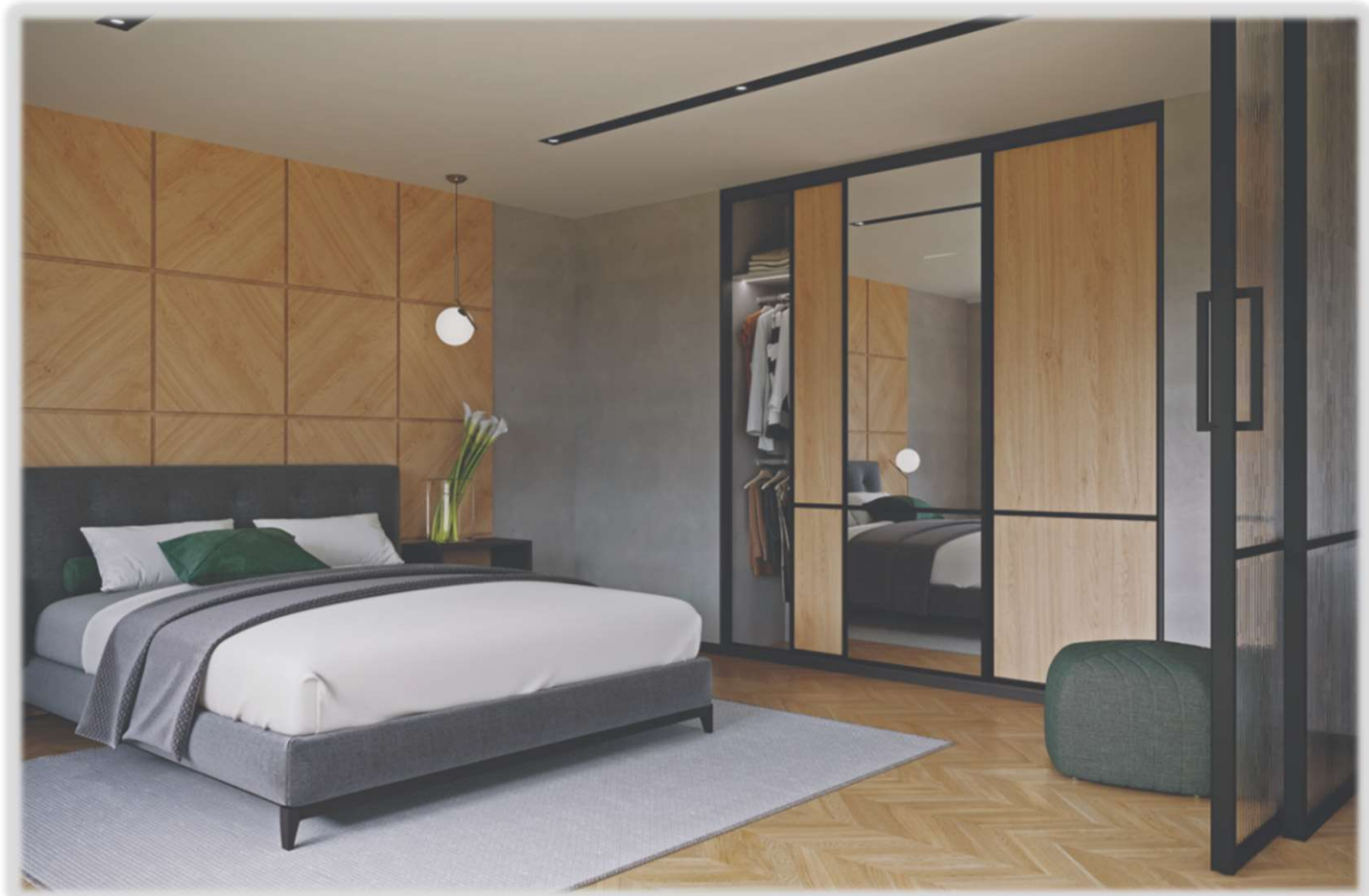

MAGNETYT system



Magnetyt – interesting, harmonious shape that's structure is architecturally pleasing. The slim lime, delicate roundness at the edge of the frame and its perfect composition makes Magnetyt an aristocrat among profiles of a similar character. It is a profile that stands out against the background of the door insert material, forming its visible frame. Magnetyt makes wardrobes look elegant and classy, and at the same time modern and fresh. It goes perfectly with the classic, retro, vintage, industrial, Scandinavian, eclectic and contemporary styles.

The Magnetyt system allows for the production of sliding doors and the combination of various insert materials within one door. It is also possible to use decorative strips in the colour of the system

PARAMETERS

- max door height: 2.75 m
- max door width: 1.25 m

- anti-jumping function protects the door against falling out of the bottom track
- buffer strips with short and long hair reduce vibrations when closing the door and protect the interior against dust
- rollers equipped with bearings ensure light door sliding with ease
- quiet work of the running gear
- possibility of using the door closers ensuring soft closing of the door

6



PROFILE COLORS

silver





Magnetyt



Insert materials - Glazing

PLEASE NOTE: Standard and Lux doors are constructed with rollers that protrude beyond the profile and therefore do not lend themselves to transparent glass.

Float Glass



Clear & Coloured Mirrors



Acid Etched Glass



Back Painted Glass



Over 20 styles

- regular or matte finish
- various colours
- ultra-clear and metallic

Pattern Glass

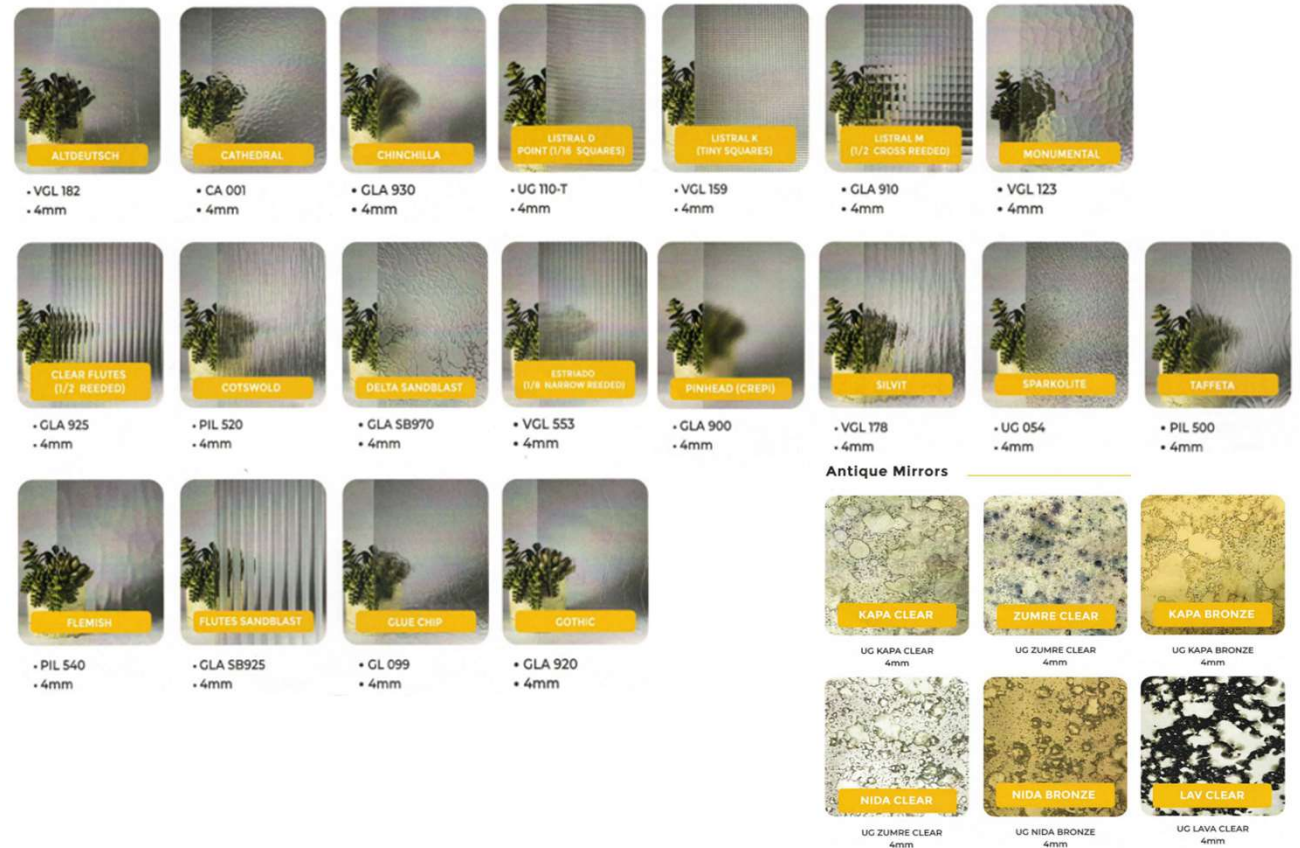

Insert materials - Panel

European low VOC imports – below is a small sampling of finishes offered

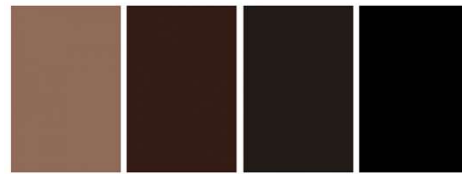

Textured
High Gloss
SuperMatt
Specialty
Soft Touch





STANDARD, LUX



DRZWI PRZESUWNE SERIA 10 - STANDARD, LUX
DRZWI UCHYLNE SERIA 10 - STANDARD, LUX
DRZWI ZE SKOSEM SERIA 10 - LUX

ST 10



DRZWI PRZESUWNE SERIA 10 SLIDING DOORS THE 10 SERIES

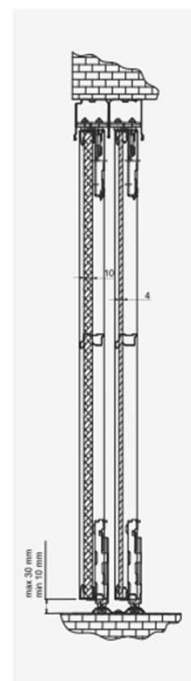

W = 400-1250 mm - panel 10 mm
W = 400-1000 mm - glass 4 mm

STANDARD SYSTEM

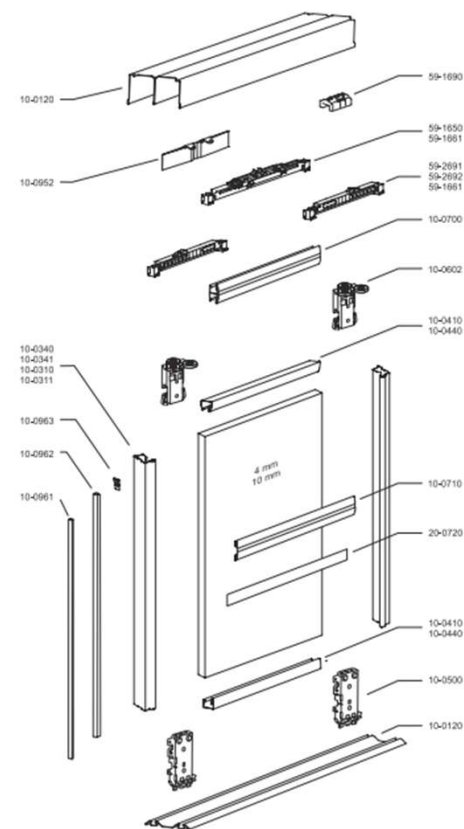

- 10-0120
- 10-0952
- 10-0340
- 10-0341
- 10-0311
- 10-0963
- 10-0962
- 10-0961
- 59-1690
- 59-1650
- 59-1661
- 59-2891
- 59-2892
- 59-1661
- 10-0700
- 10-0002
- 10-0410
- 10-0440
- 10-0710
- 20-0720
- 10-0410
- 10-0440
- 10-0500
- 10-0120



STANDARD

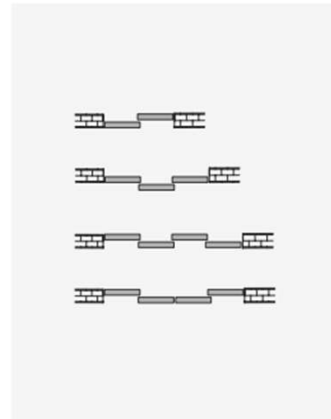
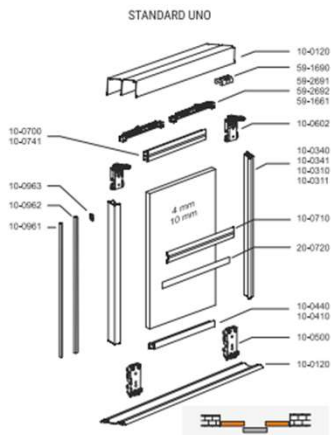
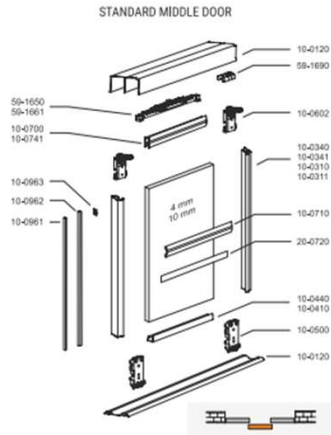
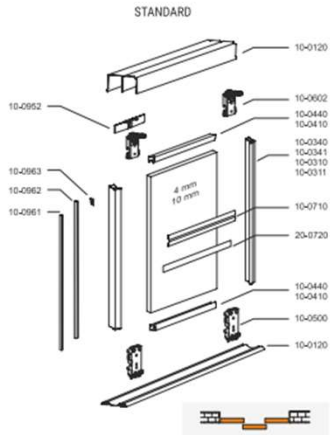

DRZWI PRZESUWNE SERIA 10
SLIDING DOORS THE 10 SERIES

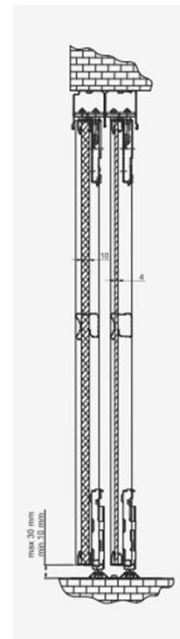

W = 400+1250 mm - panel 10 mm
W = 400+1250 mm - glass 4 mm

LUX SYSTEM

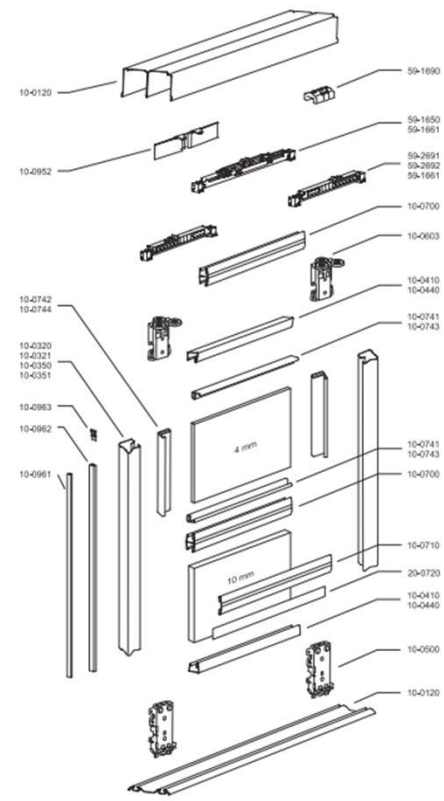



LUX

LUX

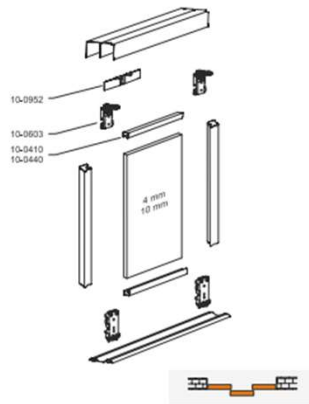

LUX MIDDLE DOOR

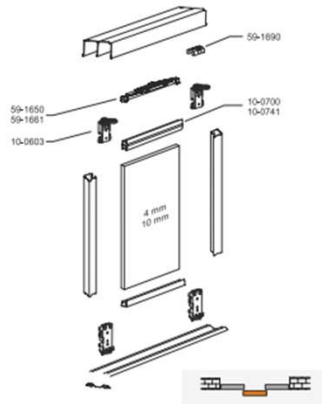

LUX UNO

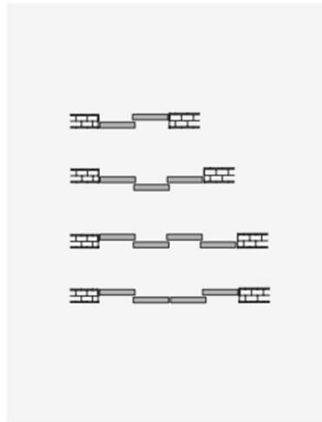
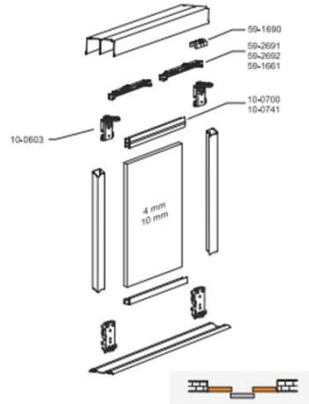

DRZWI PRZESUWNE SERIA 10
SLIDING DOORS THE 10 SERIES



10-0120-#

Top górny i dolny 5500 mm
Top and bottom track 5500 mm
Rail haut et bas 5500 mm

- BL, BU, CZ, DN, KL, MS, MZ, OR, WE, WI

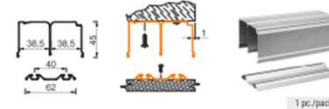

10-0310-#

Ramiak pionowy STANDARD 10x2750 mm
STANDARD stile 10x2750 mm
Montant STANDARD 10x2750 mm

- BL, BU, CZ, DN, KL, MS, MZ, OR, WI



10-0311-MS

Ramiak pionowy STANDARD 10x2550 mm
STANDARD stile 10x2550 mm
Montant STANDARD 10x2550 mm

- BL, BU, CZ, DN, KL, MS, MZ, OR, WI



10-0340-#

Ramiak pionowy STANDARD 4x2750 mm
STANDARD stile 4x2750 mm
Montant STANDARD 4x2750 mm

- BL, BU, CZ, DN, KL, MS, MZ, OR, WI

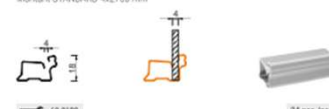

10-0341-MS

Ramiak pionowy STANDARD 4x2550 mm
STANDARD stile 4x2550 mm
Montant STANDARD 4x2550 mm

- BL, BU, CZ, DN, KL, MS, MZ, OR, WI



10-0320-#

Ramiak pionowy LUX 10x2750 mm
LUX stile 10x2750 mm
Montant LUX 10x2750 mm

- BL, BU, CZ, DN, KL, MS, MZ, OR, WI

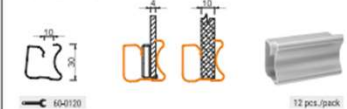

10-0321-#

Ramiak pionowy LUX 10x2550 mm
LUX stile 10x2550 mm
Montant LUX 10x2550 mm

- MS, MZ

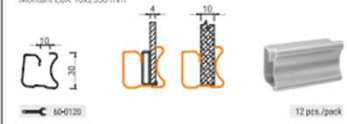

10-0350-#

Ramiak pionowy LUX 4x2750 mm
LUX stile 4x2750 mm
Montant LUX 4x2750 mm

- BL, BU, CZ, DN, KL, MS, MZ, OR, WI

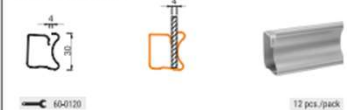

10-0351-#

Ramiak pionowy LUX 4x2550 mm
LUX stile 4x2550 mm
Montant LUX 4x2550 mm

- MS, MZ

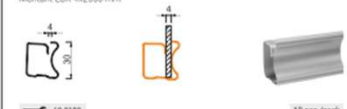

10-0410-#

Ramiak poziomy 10x1800 mm
Rail 10x1800 mm
Traverse 10x1800 mm

- BL, BU, CZ, DN, KL, MS, MZ, OR, WI

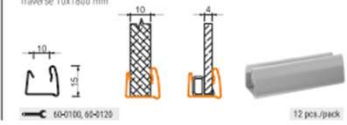



STANDARD, LUX

10-0440-# # - BL, BU, CZ, DN, KL, MS, MZ, OR, WI
Ramiak poziomy 4x1800 mm
Rail 4x1800 mm
Traverse 4x1800 mm

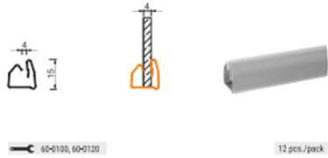

12 pcs./pack

10-0700-# # - BL, BU, CZ, DN, KL, MS, MZ, OR, WI, WT
Ramiak łączący 1800 mm
Joiner rail 1800 mm
Traverse en "H" 1800 mm

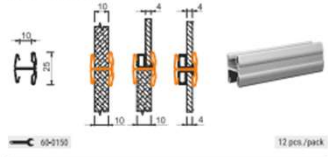

12 pcs./pack

10-0710-# # - BL, BU, CZ, DN, KL, MS, MZ, OR, WI, WT
Listwa ozdobna sztabowa 1800 mm
Steel decorative batten 1800 mm
Baguette décorative acier 1800 mm

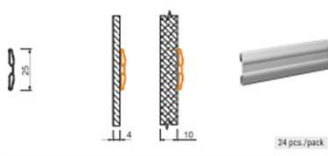

24 pcs./pack

20-0720
Tępa dwustronna piankowa 0,019x10 m
Doux à double face B. 019x10 m
Bande en mousse adhesive double face 0,019x10 m

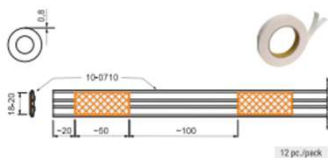

12 pcs./pack

10-0741
Listwa dystansowa 6x10x1800 mm
Distance batten 6x10x1800 mm
Joint de compensation 6x10x1800 mm

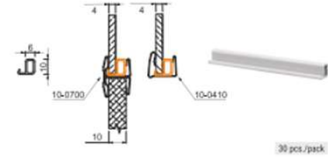

30 pcs./pack

10-0742
Listwa dystansowa 6x25x2750 mm
Distance batten 6x25x2750 mm
Joint de compensation 6x25x2750 mm

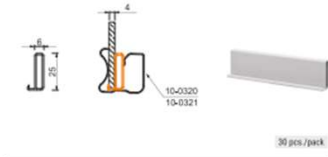

30 pcs./pack

10-0743
Listwa dystansowa 5,3x10x1800 mm
Distance batten 5,3x10x1800 mm
Joint de compensation 6x25x2750 mm

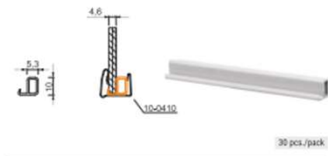

30 pcs./pack

10-0744
Listwa dystansowa 5,3x25x2750 mm
Distance batten 5,3x25x2750 mm
Joint de compensation 5,3x25x2750 mm

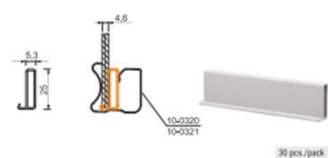

30 pcs./pack

DRZWI PRZESUWNE SERIA 10 SLIDING DOORS THE 10 SERIES



10-0500
Wózek doły
Anti-jump roller
Roulement bas à billes

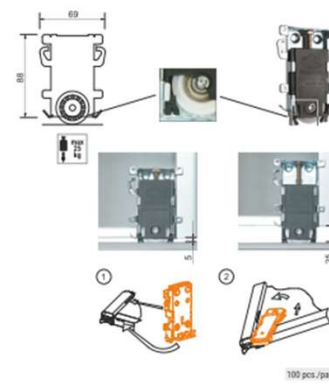

100 pcs./pack

10-0602
Prowadnik górny trzypłkowy
Top tripl-roller guide
Guide haut à 3 roulettes

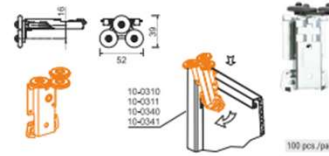

100 pcs./pack

10-0603
Prowadnik górny trzypłkowy LUX
Top tripl-roller guide LUX
Guide haut LUX à 3 roulettes

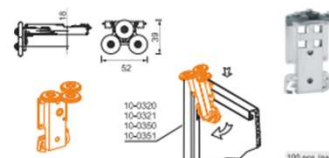

100 pcs./pack

10-0952-# # - BL, CZ
Stoper uniwersalny (70 szt.)
Universal stopper (70 pcs.)
Stoppeur (70 pcs.)

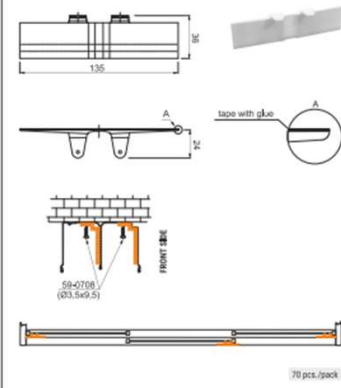

70 pcs./pack

59-1970
Zamek do drzwi przesuwnych
Sliding door lock
Serrure de porte coulissante

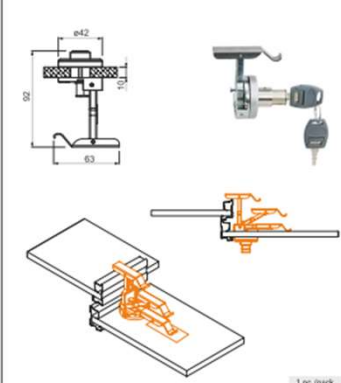

1 pc./pack

DRZWI PRZESUWNE SERIA 10 SLIDING DOORS THE 10 SERIES



25-0977

Zaczep ploski blakady drzwi
Door lock flat catch
Gache plate de porte

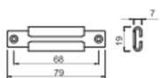

10 pcs./pack

10-0961

Pasek buforowy samoprzylepny krótki (275 m/rolka)
Self-adhesive buffer strip, short haired (275 m/roll)
Joint Brasse adhésif court (275 m/rouleau)



275 m/roll 4 rolls/pack

10-0962

Pasek buforowy samoprzylepny dlugi (150 m/rolka)
Self-adhesive buffer strip, long haired (150 m/roll)
Joint Brasse adhésif long (150 m/rouleau)



150 m/roll 3 rolls/pack

10-0963

Zapinka do paska buforowego (250 szt.)
Buffer strip clip (250 pcs.)
Agraf pour joint brasse (250 pcs.)



250 pcs./pack

59-0702

Wkręt do montażu 3,5x16 mm (1000 szt.)
Mounting screw 3.5x16 (1000 pcs.)
Vis de montage 3,5x16 mm (1000 pcs.)



1000 pcs./pack

59-0708

Wkręt do montażu 3,5x9,5 (1000 szt.)
Mounting screw 3.5x9.5 (1000 pcs.)
Vis de montage 3,5x9,5 mm (1000 pcs.)



1000 pcs./pack

59-0729

Wkręt do śluch samowierzący z łbem stożkowym 3,5x13 (1000 szt.)
Countersunk self-drilling screw 3.5x13 (1000 pcs.)
Vis à tige conique 3,5x13 (1000 pcs.)



1000 pcs./pack

59-1650

Domykacz środkowy
Middle doors air spring
Amortisseur central



10-16 kg

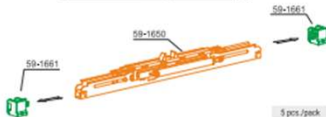

5 pcs./pack



STANDARD, LUX

59-2691

Domykacz Uno 25 kg
Uno air spring 25 kg
Amortisseur Uno 25 kg



10-25 kg

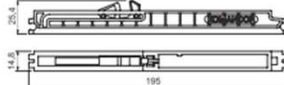

20 pcs./pack

59-2692

Domykacz Uno 50 kg
Uno air spring 50 kg
Amortisseur Uno 50 kg



10-50 kg

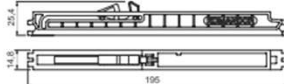

20 pcs./pack

59-1661

Zaczep domykacza środkowego / Uno ST10
Middle doors air spring / Uno spring mount ST10
Attache d'amortisseur central / Uno ST10

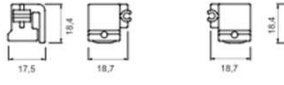

20 sets/pack

59-2691 / 59-2692

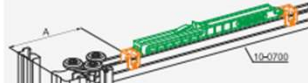

System	A [mm]
Uno	72
Standard	58

59-1650

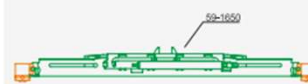

DRZWI PRZESUWNE SERIA 10 SLIDING DOORS THE 10 SERIES



59-1690

Chwytnik domykacza Comfort Touch (40 szt.)
Comfort Touch spring catch (40 pcs)
Doigt d'entrainement pour amortisseur Comfort Touch (40 pcs.)

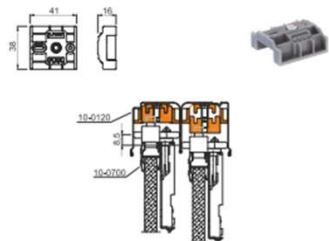

59-2691 / 59-2692 / 59-1661

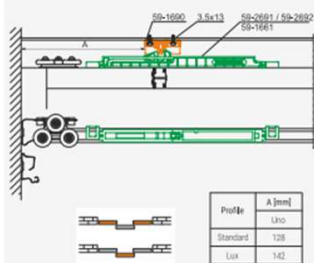

59-1650 / 59-1661

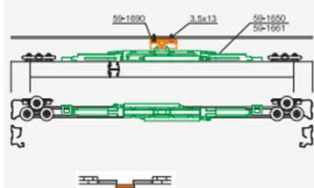

40 pcs./pack

59-2970

Zamek sterowany elektronicznie
Electronic lock
Serure électrique

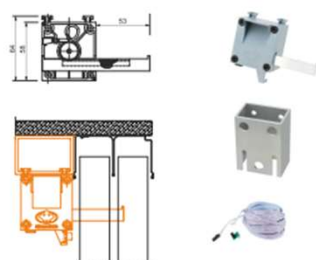

2 pcs./pack

59-2971

Zaczep ryglący (10 szt.)
Latch hook (10 pcs)
Gâche de serrure (10 pcs.)

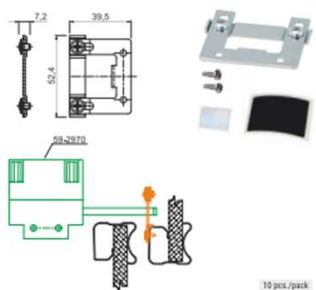

10 pcs./pack

59-2980

Zespół sterujący zamkiem elektronicznym
Electronic lock controller
Serure à code



1 pc./pack





MAGNETYT



H = 2750 mm max.
W = 550+1250 mm - panel 10 mm
W = 550+1250 mm - glass 4 mm

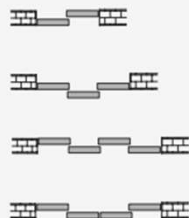

DRZWI PRZESUWNE SERIA 11 SLIDING DOORS THE 11 SERIES



MAGNETYT SYSTEM

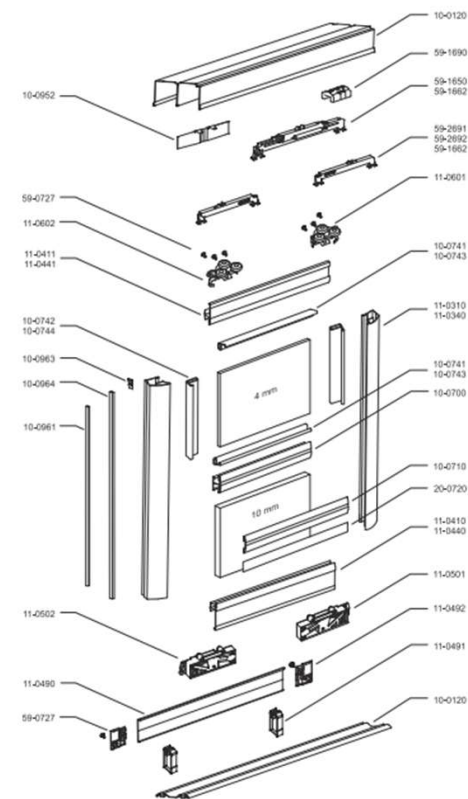
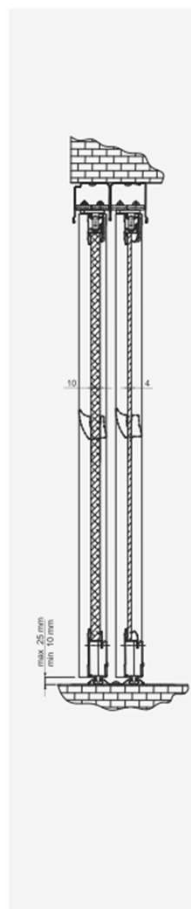



MAGNETYT

MAGNETYT

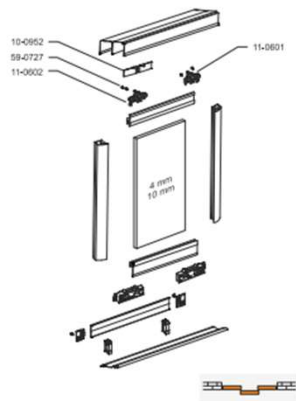

MAGNETYT MIDDLE DOOR

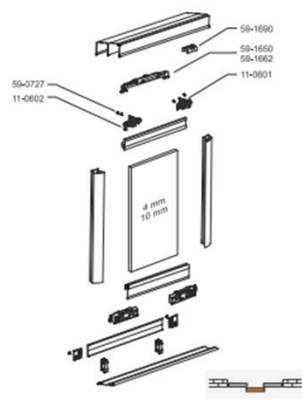

MAGNETYT UNO

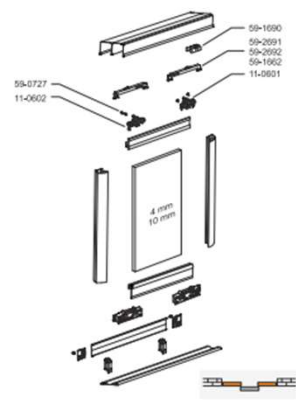

DRZWI PRZESUWNE SERIA 11 SLIDING DOORS THE 11 SERIES



10-0120-#

Top górný i dolný 5500 mm
Top and bottom track 5500 mm
Rail haut et bas 5500 mm

- BL, BU, CZ, DN, KL, MS, MZ, DR, WE, WI

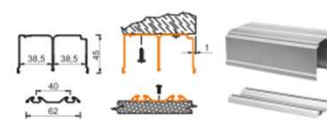

12 pcs./pack

11-0310-#

Ramiak pionowy MAGNETYT 10x2750 mm
MAGNETYT stłk 10x2750 mm
Montant MAGNETYT 10x2750 mm

- BL, CZ, MS, MZ, DR, WE, WI

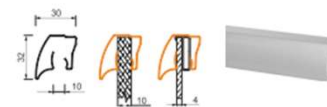

12 pcs./pack

11-0340-#

Ramiak pionowy MAGNETYT 4x2750 mm
MAGNETYT stłk 4x2750 mm
Montant MAGNETYT 4x2750 mm

- BL, CZ, MS, MZ, DR, WE, WI



12 pcs./pack

11-0410-#

Ramiak poziomy MAGNETYT 10x1800 mm
MAGNETYT rail 10x1800 mm
Traverse MAGNETYT 10x1800 mm

- BL, CZ, MS, MZ, DR, WE, WI

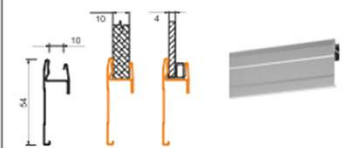

12 pcs./pack

11-0440-#

Ramiak poziomy MAGNETYT 4x1800 mm
MAGNETYT rail 4x1800 mm
Traverse MAGNETYT 4x1800 mm

- BL, CZ, MS, MZ, DR, WE, WI

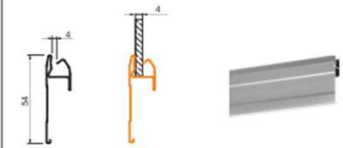

12 pcs./pack

11-0411-#

Ramiak poziomy górný MAGNETYT 10x1800 mm
MAGNETYT top rail 10x1800 mm
Traverse haute MAGNETYT 10x1800 mm

- BL, CZ, MS, MZ, DR, WE, WI



12 pcs./pack



MAGNETYT

11-0441-# # - BL, CZ, MS, MZ, OR, WE, WI
 Ramałak poczynny górný MAGNETYT 4x1800 mm
 MAGNETYT top rail 4x1800 mm
 Traverse haute MAGNETYT 4x1800 mm

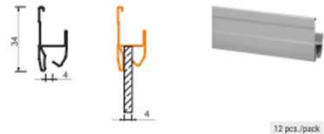

12 pcs./pack

10-0700-# # - BL, BC, BU, CZ, DN, KL, MR, MS, MZ, OR, WE, WI
 Ramałak łączący 1800 mm
 Joiner rail 1800 mm
 Traverse en "Y" 1800 mm

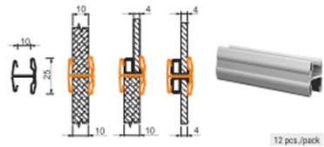

12 pcs./pack

10-0710-# # - BL, BU, CZ, DN, KL, MS, MZ, OR, WE, WI
 Listwa ozdobna stalowa 1800 mm
 Steel decorative batten 1800 mm
 Baguette décorative acier 1800 mm

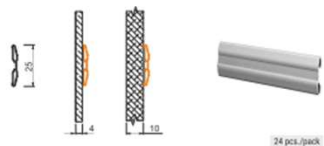

24 pcs./pack

20-0720
 Taśma dwustronna piankowa 0,019x10 m
 Double-sided foam tape 0.019x10 m
 Bande en mousse adhésive double face 0,019x10 m

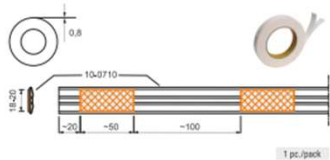

1 pc./pack

10-0741
 Listwa dystansowa 6x10x1800 mm
 Distance batten 6x10x1800 mm
 Joint de compensation 6x10x1800 mm

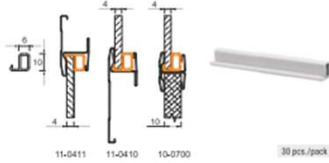

30 pcs./pack

10-0742
 Listwa dystansowa 6x25x2750 mm
 Distance batten 6x25x2750 mm
 Joint de compensation 6x25x2750 mm

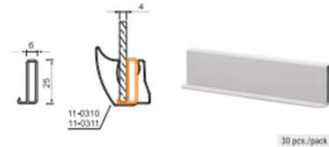

30 pcs./pack

10-0743
 Listwa dystansowa 5,3x10x1800 mm
 Distance batten 5.3x10x1800 mm
 Joint de compensation 5,3x10x1800 mm

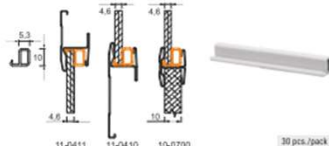

30 pcs./pack

10-0744
 Listwa dystansowa 5,3x25x2750 mm
 Distance batten 5.3x25x2750 mm
 Joint de compensation 5,3x25x2750 mm

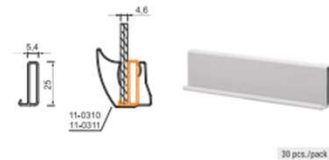

30 pcs./pack

DRZWI PRZESUWNE SERIA 11 SLIDING DOORS THE 11 SERIES



11-0501
 Wzrostek MAGNETYT, prawy
 MAGNETYT roller, right
 Guide bas MAGNETYT, droit

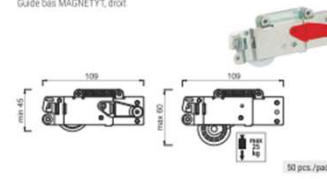

50 pcs./pack

11-0502
 Wzrostek MAGNETYT, lewy
 MAGNETYT roller, left
 Guide bas MAGNETYT, gauche

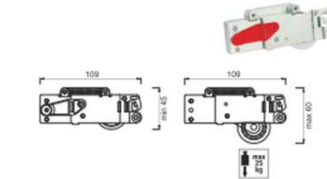

50 pcs./pack

11-0492
 Zaczep maskownicy lewy+prawy (50 szt.)
 Masking strip catch, left+right (50 pcs.)
 Support cache traverse latéral (50 pcs.)

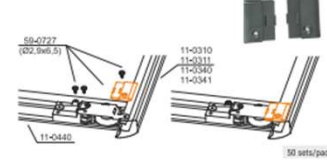

50 sets/pack

11-0491
 Koszka maskownicy MAGNETYT (100 szt.)
 MAGNETYT masking strip (100 pcs.)
 Support cache traverse central MAGNETYT (100 pcs.)



100 pcs./pack

11-0490-# # - MS, MZ, OR, WE, WI
 Maskownica ramałki MAGNETYT 2750 mm
 MAGNETYT rail masking strip, 2750 mm
 Bardeau sous l'entrou MAGNETYT 2750 mm

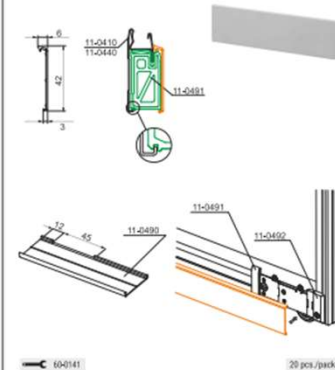

20 pcs./pack

11-0601
 Przewodnik górný trzyczółkowy MAGNETYT, prawy
 MAGNETYT top triple-roller guide, right
 Guide haut MAGNETYT, droit

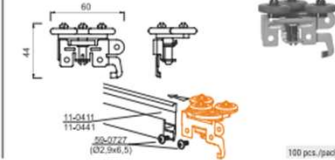

100 pcs./pack



MAGNETYT

11-0602

Przewodnik górny trzypółkowy MAGNETYT lewy
MAGNETYT top single-roller guide, left
Guide haut MAGNETYT, gauche

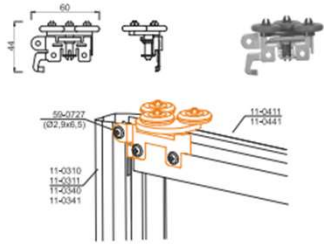

100 pcs./pack

10-0952-#

Stoper uniwersalny (70 szt.)
Universal stopper (70 pcs.)
Stoppeur (70 pcs.)

A - BŁ, CZ

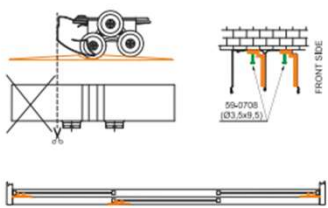
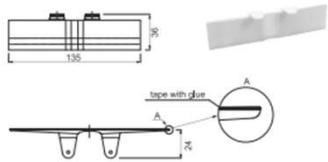

70 pcs./pack

10-0961

Pasek buforowy samoprzylepny krótki (275 m/rolka)
Self-adhesive buffer strip, short haired (275 m/roll)
Joint Brosse adhésif court (275 m/rouleau)

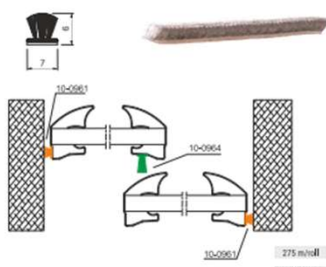

4 roll/pack

10-0964

Pasek buforowy samoprzylepny 10 mm (150 m/rolka)
Self-adhesive buffer strip, 10 mm (150 m/roll)
Joint Brosse adhésif 10 mm (150 m/rouleau)



3 roll/pack

10-0963

Zapenka do paska buforowego (250 szt.)
Buffer strip clip (250 pcs.)
Agraf pour joint brosse (500 pcs.)

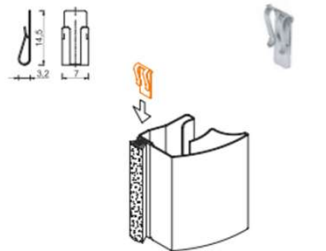

250 pcs./pack

DRZWI PRZESUWNE SERIA 11 SLIDING DOORS THE 11 SERIES



59-2691

Domykacz UNO 25 kg
UNO air spring 25 kg
Amortisseur UNO 25 kg

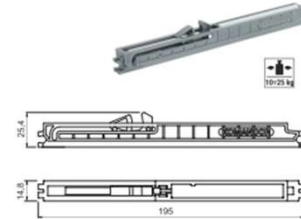

19-25 kg

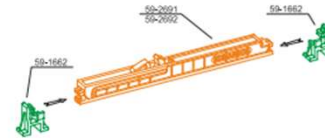

20 pcs./pack

59-2692

Domykacz UNO 50 kg
UNO air spring 50 kg
Amortisseur UNO 50 kg

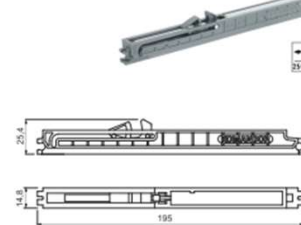

25-50 kg

20 pcs./pack

59-1650

Domykacz środkowy
Middle doors air spring
Amortisseur central

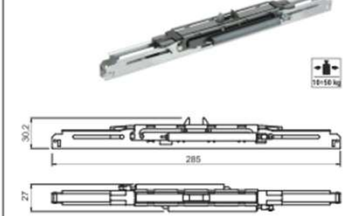

18-18 kg

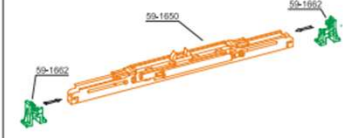

5 pcs./pack

59-1662

Zaczepek domykača (środkowego / UNO ST11)
Middle doors air spring / UNO spring mount ST11
Attache d'amortisseur central / UNO ST11

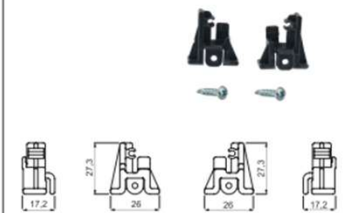

20 pcs./pack



MAGNETYT

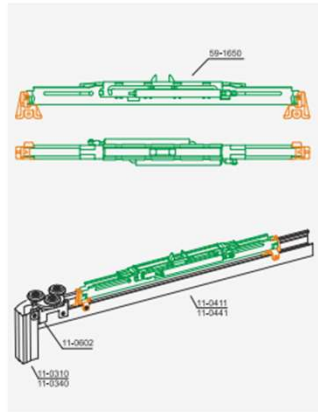

59-1690
Chwytyk domykacza Comfort Touch (40 szt.)
Comfort Touch spring catch (40 pcs.)
Doigt d'entraînement pour amortisseur Comfort Touch (40 pcs.)

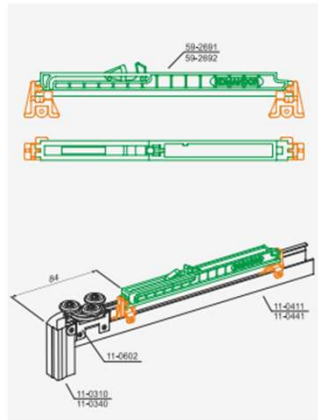
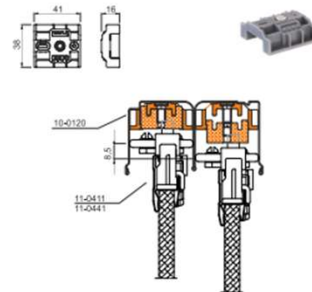

20 sets./pack

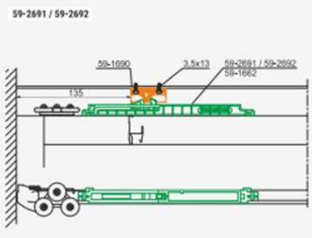

40 pcs./pack

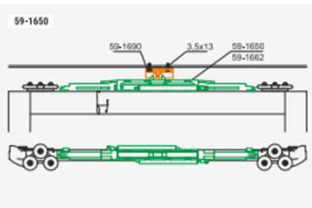

59-1650

DRZWI PRZESUWNE SERIA 11
SLIDING DOORS THE 11 SERIES



59-1970
Zamek do drzwi przesuwnych
Sliding door lock
Serrure de porte coulissante

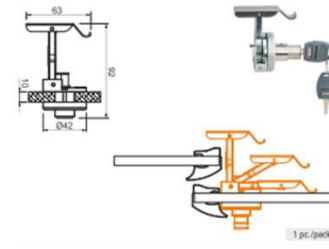

1 pc./pack

59-0708
Wkręt do montażu 3,5x9,5 (1000 szt.)
Mounting screw 3.5x9.5 (1000 pcs.)
Vis de montage 3,5x9,5 mm (1000 pcs.)

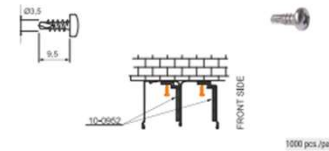

1000 pcs./pack

59-0727
Wkręt do montażu 2,9x6,5 mm (1000 szt.)
Mounting screw 2.9x6.5 mm (1000 pcs.)
Vis de montage 2,9x6,5 mm (1000 pcs.)

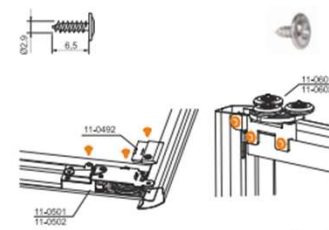

1000 pcs./pack

59-2970
Zamek sterowany elektronicznie
Electronic lock
Serrure électrique

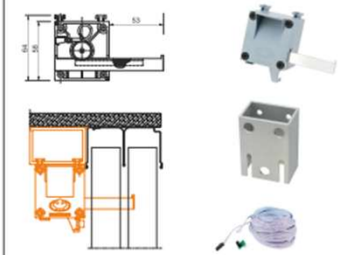

2 pcs./pack

59-2971
Zaczep rygla (10 szt.)
Latch hook (10 pcs.)
Gâche de serrure (10 pcs.)

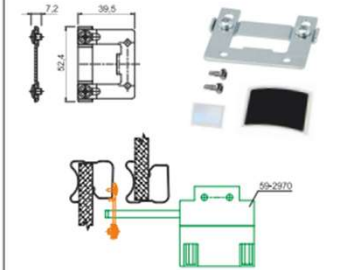

10 pcs./pack

59-2980
Zestaw sterujący zamkiem elektronicznym
Electronic lock controller
Serrure à code



1 pc./pack



KOMANDOR CANADA CLOSETS & DOORS INC.
863 Rangeview Rd., Mississauga, ON L5E 1H1
tel: 905.766.0880 www.komandor.ca